



DE Series
In-wall / In-ceiling
Speakers

Next Generation



pure listening 



DE Series NEXT GENERATION

Our latest **DE Series** sets new standards in highend, in-wall/in-ceiling sound systems and feature an elegant and slim installation frame. Compact dimensions and perfect acoustics are just some of the highlights of this new series. The installation height of the sophisticated metal installation frame of our round, square, and rectangular models is just 1.2 mm while the ultra-compact design means that only a minimum amount of installation space is required in ceilings and walls.

Thanks to the modular concept comprising an installation frame, speaker unit, and magnetic front grille, the speakers can be installed flexibly and securely

in any type of ceiling or wall. Depending on requirements and room/situation, the various models in the DE Series can be combined to create impressive and visually harmonious sound systems.

The models with optimized Polar® technology are designed for exceptionally consistent sound transmission from the in-ceiling sound system, even with just a few speakers. They offer a dispersion angle of 180°.

The models in the CD and FR Series feature targeted dispersion and are especially suitable as front speakers in AV systems and conference spaces.

SLIM
DESIGN

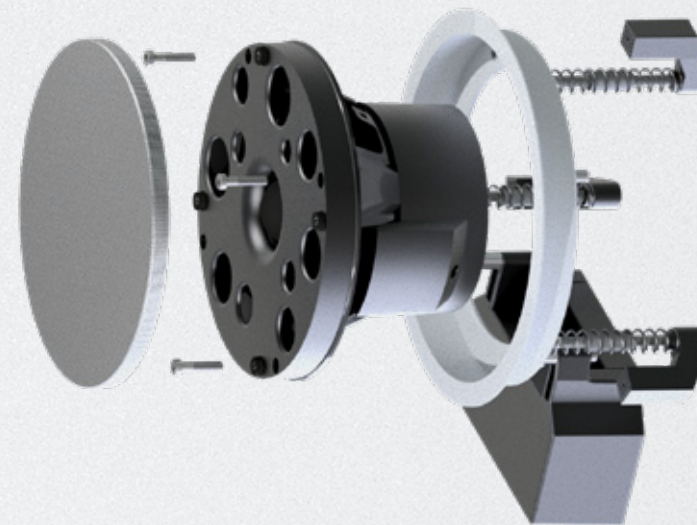

**OPTIMAL FLEXIBILITY
DURING INSTALLATION**
Modular construction
of our **DE** and **DE-X Series**

To ensure natural reproduction and perfect acoustic dispersion, we have further optimized our new generation of patented coaxial drivers that feature **Polar® technology**.

ULTRA-COMPACT STRUCTURE



Round models

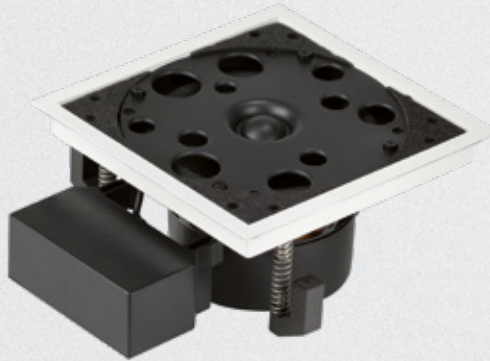

Square models



Installation height of just 1.2 mm

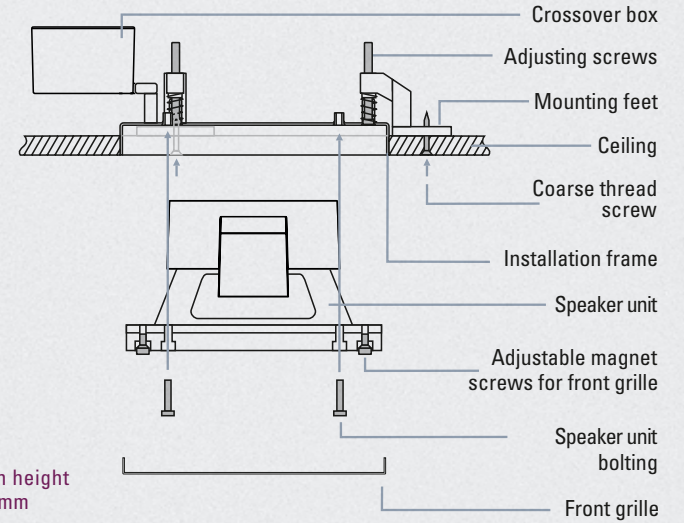

- ELEGANT METAL FRAMES
- FLEXIBLE ASSEMBLY WITH CLAMPS
- INTEGRATED CROSSOVER BOX
- OPTIMIZED POLAR® TECHNOLOGY



Clientis Bank Oberuzwil CH, In-ceiling sound system with DE Series speakers



DE Series MODELS WITH DIFFERING DISPERSION CHARACTERISTICS

Polar® Speakers

Uncompromising two-way speakers with patented Polar® technology for extremely broad and even sound dispersion (180°).

With Polar speakers it is possible to homogeneously fill rooms with sound employing considerably fewer systems and greater speaker distances.

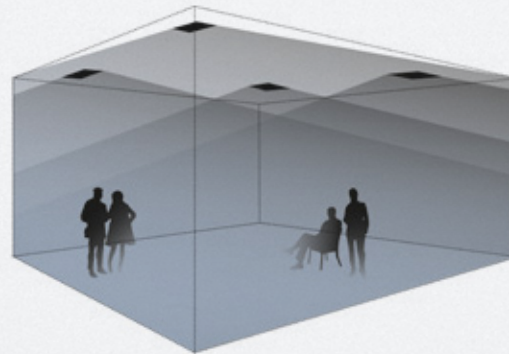

With a few Polar speakers it is possible to homogeneously fill a room with sound.

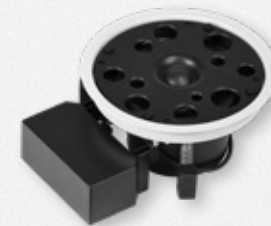

The patented coaxial chassis with Polar® technology offer perfect hemispherical dispersion.



DE 300 R Polar with additional subwoofer chassis

CD Speakers

The models **DE 200 CD** and **DE 300 CDR** are high-performance two-way in-wall speakers with a defined dispersion angle of 80°.

They are employed as front speakers (L, R, center) for home-audio systems and media rooms. A tweeter with waveguide ensures controlled sound radiation with CD characteristics (Constant Directivity).

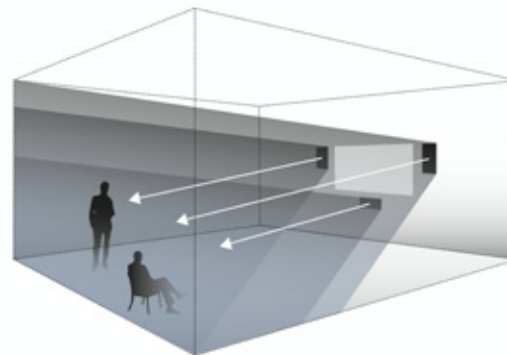

CD speaker (L, R, center) built into the wall.



The coaxial 2-way system with de:shape® waveguide creates a defined sound radiation with a constant dispersion angle of 80°.



FR Speakers

The model **DE 300 FR** is a powerful front speaker for in-ceiling installation which radiates 35° downwards. It was specially developed for employment as front speaker (L, R, center) without impairing the field of view in home-cinema applications and media rooms.

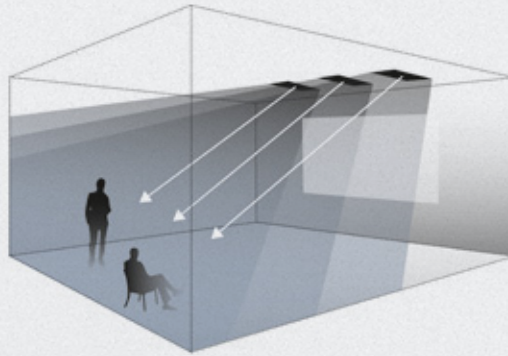

DE 300 FR front speaker (L, R, center) for home-cinema



Special design which radiates 35° downwards



A coaxial 3-way chassis with Waveguide creates the radiation direction, a second bass chassis ensures dynamic bass reproduction.

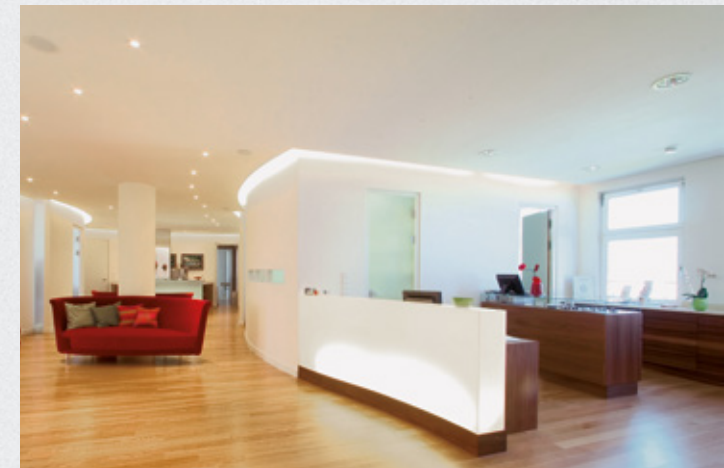

Die Hautärzte, Starnberg
Multi-zone sound system
with in-ceiling speakers



DE Series BACK BOXES

We offer suitable back boxes for installation in acoustic ceilings, solid walls or concrete ceilings.
You can find more detailed information in the DE installation instructions and the data sheets.

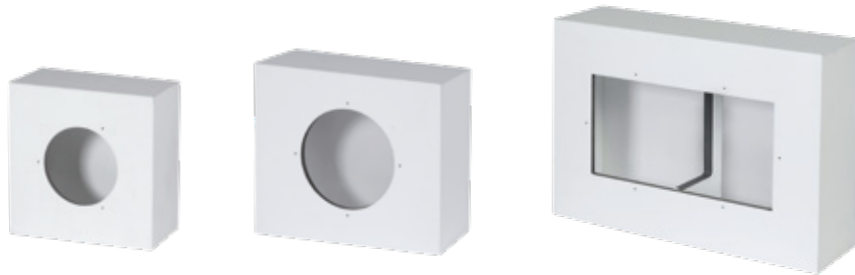

Back boxes for drywall and ceiling (EG Series)

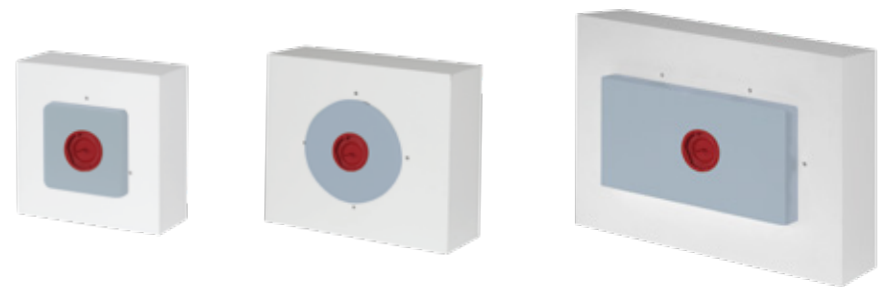

Back boxes for concrete ceilings (EGB Series)













DE installation videos with or without back box on Youtube

DE 300 – IN-CEILING INSTALLATION

First, the elegant installation frame is mounted in the ceiling or wall. The speaker unit and the magnetic front grille are then installed.

DE Series MODELS

Model	Principle	Frequency range	Power capacity	Impedance	100 V Versions	Sensitivity	Dispersion	Dimensions	Cutout size	Installation depth	Weight	Back boxes
 DE 140 Polar DE 140 Q Polar	2-way hifi speaker with Polar technology	76 ... 21000 Hz	RMS/Prog. 30/60 Watts	8 Ohms	7,5/15/30 Watts (100 V)	84 dB (1W/1m) max. 102 dB 100 V max. 99 dB	180°	d=144 mm 144 x 144 mm (Q)	d=128 mm 128 x 128 mm (Q)	83 mm	1,2 kg	EG 140 / EGB 140 EG 140 Q / EGB 140 Q
 DE 170 Polar DE 170 Q Polar	2-way hifi speaker with Polar technology	60 ... 21000 Hz	RMS/Prog. 40/80 Watts	8 Ohms	7,5/15/30 Watts (100 V)	86 dB (1W/1m) max. 105 dB 100 V max. 101 dB	180°	d=174 mm 174 x 174 mm (Q)	d=158 mm 158 x 158 mm (Q)	88 mm	1,7 kg	EG 170 / EGB 170 EG 170 Q / EGB 170 Q
 DE 200 Polar DE 200 Q Polar	2-way hifi speaker with Polar technology	54 ... 21000 Hz	RMS/Prog. 60/120 Watts	8 Ohms	7,5/15/30 Watts (100 V)	87 dB (1W/1m) max. 108 dB 100 V max. 102 dB	180°	d=192 mm 192x192 mm (Q)	d=176 mm 176x176 mm (Q)	100 mm	2,1 kg	EG 200 / EGB 200 EG 200 Q / EGB 200 Q
 DE 200 HSP DE 200 HSPQ Polar	2-way hifi speaker with Polar technology	96 ... 21000 Hz	RMS/Prog. 60/120 Watts	8 Ohms	7,5/15/30 Watts (100 V)	93 dB (1W/1m) max. 114 dB 100 V max. 109 dB	180°	d=192 mm 192x192 mm (Q)	d=176 mm 176x176 mm (Q)	102 mm	2,9 kg	EG 200 / EGB 200 EG 200 Q / EGB 200 Q
 DE 300 R Polar	3-way hifi speaker with Polar technology	52 ... 21000 Hz	RMS/Prog. 120/240 Watts	4 Ohms	on request	89 dB (1W/1m) max. 112 dB	180°	358x192 mm	342x176 mm	100 mm	3,8 kg	EG 300 / EGB 300
 DE 200 LP DE 200 LPQ	2-way hifi speaker with reduced mounting depth	75 ... 21000 Hz	RMS/Prog. 40/80 Watts	8 Ohms	7,5/15/30 Watts (100 V)	85 dB (1W/1m) max. 104 dB 100 V max. 100 dB	140°	d=192 mm 192x192 mm (Q)	d=176 mm 176x176 mm (Q)	50 mm	1,2 kg	EG 200 / EGB 200 EG 200 Q / EGB 200 Q
 DE 200 CD DE 200 CDQ	2-way hifi in-wall speaker	54 ... 21000 Hz	RMS/Prog. 60/120 Watts	8 Ohms	on request	88 dB (1W/1m) max. 109 dB	80°	d=192 mm 192x192 mm (Q)	d=176 mm 176x176 mm (Q)	100 mm	2,1 kg	EG 200 / EGB 200 EG 200 Q / EGB 200 Q
 DE 300 CDR	3-way hifi in-wall speaker	52 ... 21000 Hz	RMS/Prog. 120/240 Watts	4 Ohms	on request	89 dB (1W/1m) max. 112 dB	80°	358x192 mm	342x176 mm	100 mm	3,8 kg	EG 300 / EGB 300
 DE 300 FR	3-way in-ceiling speaker with Polar technology	57 ... 21000 Hz	RMS/Prog. 80/160 Watts	4 Ohms	on request	87 dB (1W/1m) max. 109 dB	80°, Beam direction -35° downwards	358x192 mm	342x176 mm	150 mm	4,2 kg	EG 300 FR / EGB 300 FR
 DE 200 ST Polar DE 200 STQ Polar	Stereo 2-way in-ceiling speaker with Polar technology	54 ... 21000 Hz	RMS/Prog. 2 x 40/80 Watts	2 x 8 Ohms	on request	86 dB (1W/1m) max. 108 dB	180°	d=192 mm 192 x 192 mm (Q)	d=176 mm 176x176 mm (Q)	100 mm	2,2 kg	EG 200 / EGB 200 EG 200 Q / EGB 200 Q
 DE 300 SUB	Subwoofer	40 ... 250 Hz	RMS/Prog. 120/240 Watts	4 Ohms	on request	83 dB (1W/1m) max. 107 dB	180°	358x192 mm	342x176 mm	100 mm	4,2 kg	EG 300 / EGB 300

LB Lautsprecher und
Beschallungstechnik GmbH

info@lb-lautsprecher.de
www.lb-lautsprecher.de
www.feiner-hoeren.de
@LB_Audio_Components

Tel +49 89 1893109-0 · Fax -29

Kapellenstr. 10
85622 Feldkirchen
by Munich

SPECIAL DESIGNS

In the course of many years of application-related work, we have developed a large number of project-related DE special types.

Just ask – we would be happy to advise you.

Changes and errors excepted.

© LB Lautsprecher und Beschallungstechnik GmbH

pure listening 