



Installation Instructions

DE Series

In-Wall / In-Ceiling Speakers



SLIM
DESIGN



With their elegant and slim installation frame, the speakers in our new **DE Series** set a new bar for high-end built-in sound systems. Featuring compact dimensions and perfect acoustics, the round, square and rectangular models are installed with a streamlined metal frame measuring just 1.2 mm in height. This ultra-compact design means that minimal space is required for installation in walls and ceilings.

pure listening





Content

1. Models	4
2. Scope of delivery	5
3. Installation in drywall walls and ceilings	6
4. Installation in drywall walls and ceilings with a back box	8
5. Installation in solid walls using back boxes	11
6. Installation in concrete ceilings using back boxes	12
7. Installation in prefabricated concrete ceilings with the back boxes	13
8. Technical data loudspeakers	14
9. Technical data back boxes	15



**DE installation videos
with or without back box**
on Youtube

1. Models

Connectors / cable type

DE 140 Polar, DE 140 T Polar, DE 140 Q Polar, DE 140 QT Polar

2-way hifi in-ceiling speaker
with Polar technology

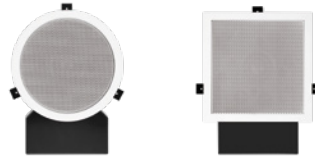

2-pole
2 x 1,5 mm² up to 30 m
2 x 2,5 mm² up to 50 m



DE 170 Polar, DE 170 T Polar, DE 170 Q Polar, DE 170 QT Polar

2-way hifi in-ceiling speaker
with Polar technology

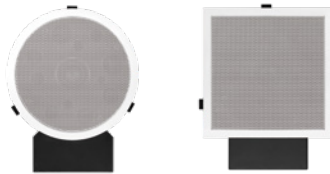

2-pole
2 x 1,5 mm² up to 30 m
2 x 2,5 mm² up to 50 m



DE 200 Polar, DE 200 T Polar, DE 200 Q Polar, DE 200 QT Polar, DE 200 HSP Polar, DE 200 HSPT Polar, DE 200 HSPQ Polar, DE 200 HSPQT Polar

2-way hifi in-ceiling speaker with Polar technology

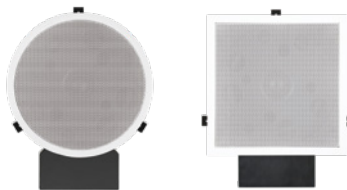

2-pole
2 x 1,5 mm² up to 30 m
2 x 2,5 mm² up to 50 m



DE 200 LP, DE 200 LPT, DE 200 LPQ, DE 200 LPQT

2-way system with reduced mounting depth

DE 200 CD, DE 200 CDQ

In-wall speakers with narrow dispersion angle

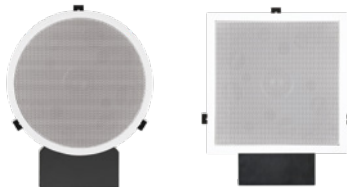

2-pole
2 x 1,5 mm² up to 30 m
2 x 2,5 mm² up to 50 m



DE 300 R

3-way in-ceiling speaker with Polar technology

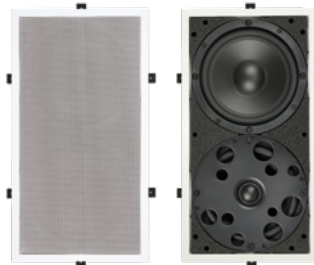

2-pole
2 x 1,5 mm² up to 20 m
2 x 2,5 mm² up to 35 m



DE 300 CDR

3-way in-wall speaker with CD characteristics

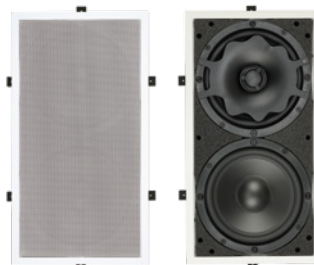

2-pole
2 x 1,5 mm² up to 20 m
2 x 2,5 mm² up to 35 m



Connectors / cable type

DE 300 FR

3-way in-ceiling front speaker,
beam direction -35° downwards

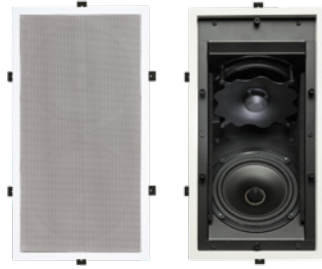

2-pole
2 x 1,5 mm² up to 20 m
2 x 2,5 mm² up to 35 m



DE 200 ST Polar, DE 200 STQ Polar

Stereo 2-way in-ceiling speaker with Polar technology

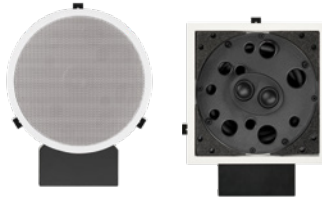

2-pole
2 x 1,5 mm² up to 30 m
2 x 2,5 mm² up to 50 m



DE 300 SUB

In-ceiling subwoofer with integrated crossover

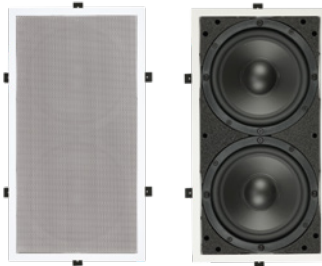

2-pole
2 x 1,5 mm² up to 20 m
2 x 2,5 mm² up to 35 m



2. Scope of delivery

- Assembly frame with springs and screws for attachment
- speaker unit
- Front grille
- Installation instructions

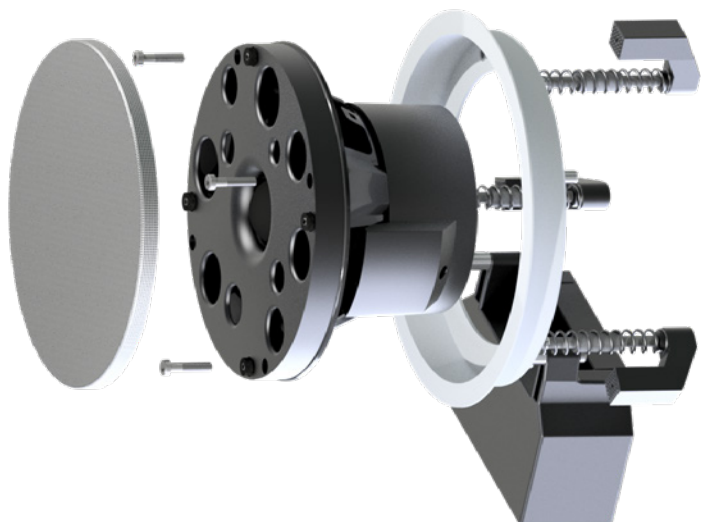

3. Installation in drywall walls and ceilings (without back box)

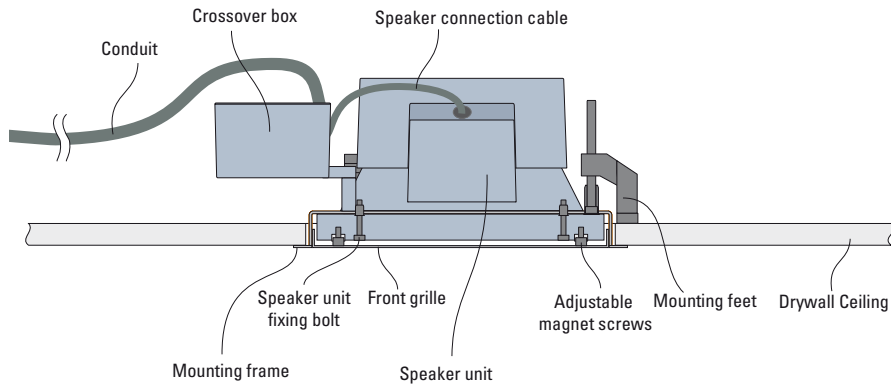

The DE Series built-in speakers can be installed directly in drywall walls and ceilings. The wall/ceiling thickness should be between 8 and 30 mm.

Installation steps



Locate and mark out the installation position.



Cut the installation opening.
For square openings use a saw to cut out the installation opening.



Trim the installation opening...



and sand the edges.

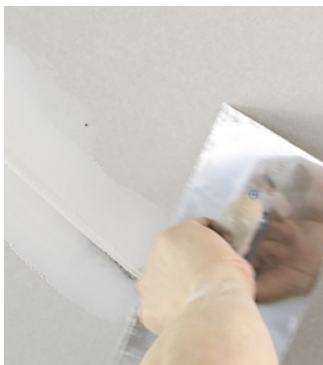

Plaster and paint.



Isolate the speaker cable and connect the system terminals.
Make sure the polarity is correct.
+ is to the right of the terminal.



Insert terminal at input of crossover.



Insert the frame and twist the mounting feet out. Screw down the mounting feet to create the right amount of tension.

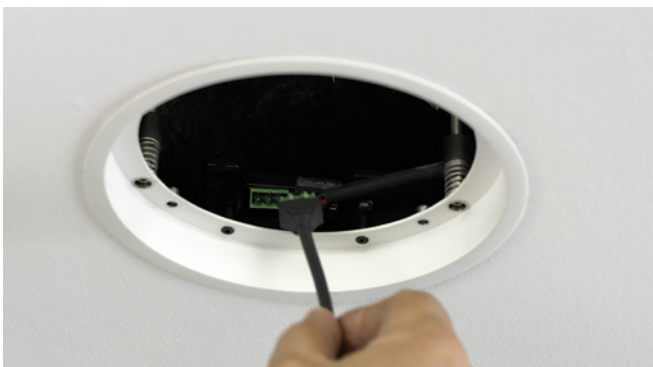

Insert cable of speaker unit into crossover.



Insert speaker unit...



and fix in place.



Test the speaker by playing music.



Insert the grille. Realign the fixing magnets if necessary.



To adjust, remove the grille with the magnetic DE tool.

4. Installation in drywall walls and ceilings with a back box (EG Series)

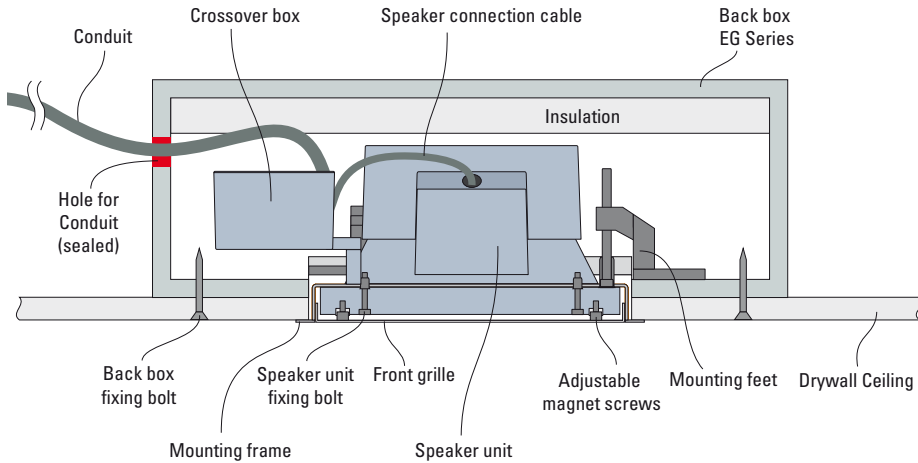

Fully installed speaker

EG Series back boxes are recommended if the installation structure is not closed (acoustic ceilings, ventilated ceilings, open recessed lighting, etc.), or if additional sound proofing for adjacent rooms is required. The use of back boxes also largely prevents vibrations in parts of the ceiling structure.

You will have to make the holes for the in-feed cables in the back boxes yourself and seal these up once the cables have been fed through.

Place the back boxes behind the drywall sheet and screw them in position.

The speakers can then be installed in the same way as for drywall walls/ceilings.

The wall/ceiling thickness should be between 8 and 30 mm.

Back boxes (EG Series)



Installation steps



Locate and mark out the installation position.



Cut the installation opening.
For round openings, use a circle cutter to cut out the installation opening.



Trim the installation opening and sand the edges.



Drill a hole in the back box for the cable.

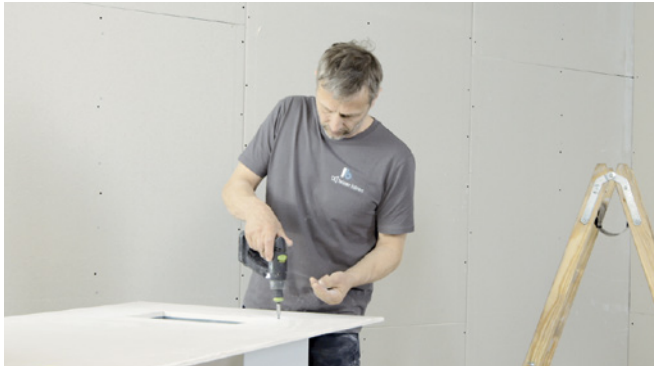

Screw the back box to the plasterboard.



Guide the cable into the back box...



and screw the plasterboard in place.



Seal the cable hole in the back box (using hot glue or sealing compound).



Plaster...



and paint the entire area.



Isolate the speaker cable. **Make sure the polarity is correct.**

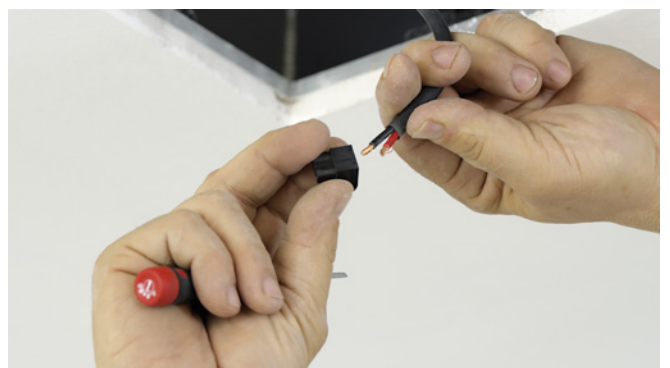

Connect the system terminals.



Line the box with insulating wool.



Unscrew the mounting feet and springs from the speaker frame.



Insert frame into opening and screw in place. The springs are not used.



Connect the speaker module. Insert terminal into correct input on the integrated crossover.



Insert speaker module and fix in place.



Test the speaker by playing music.



Insert the grille. Realign the fixing magnets if necessary.
Revision: Remove the grille using the magnetic DE tool.

5. Installation in solid walls using back boxes

Plastered solid wall with back box (EGB Series)

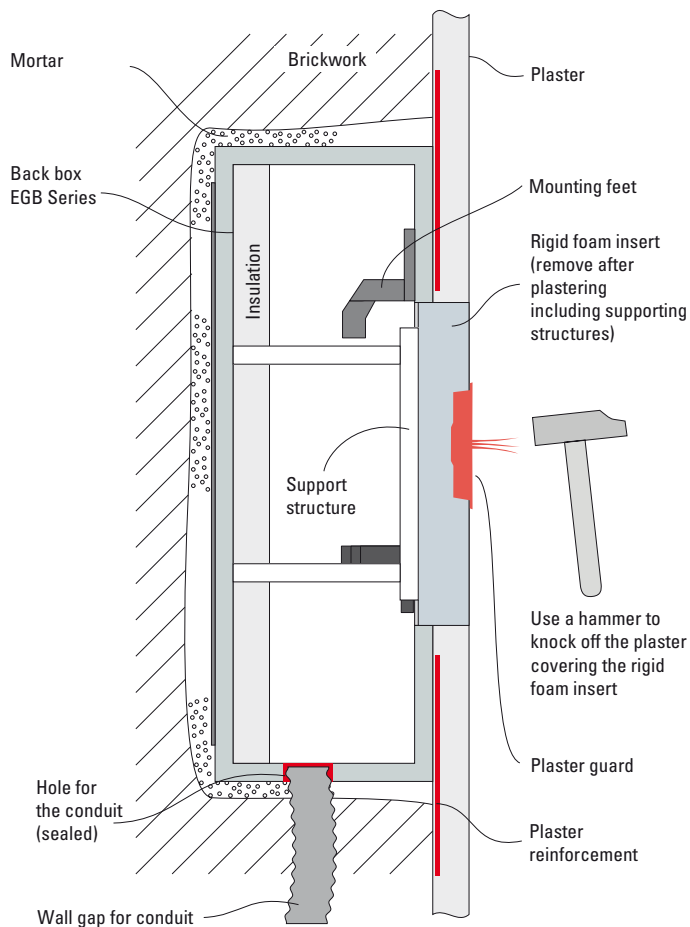

For installation in solid walls, please use our EGB-series plastic back boxes. You will have to make the holes for the in-feed cables in the back boxes yourself and seal these up once the cables have been fed through.

1. Make the opening in the brickwork.
2. Install the EGB series plastic back box using mortar or a similar material. Make sure the box is free from mechanical stress and fix in place using adhesive or plugs (otherwise the position of the speaker may shift visibly over time).
3. Use plaster base or reinforcement to avoid cracking and plaster up to the opening.

The speakers can then be installed in the same way as for drywall ceilings.

Completely installed speaker in solid wall

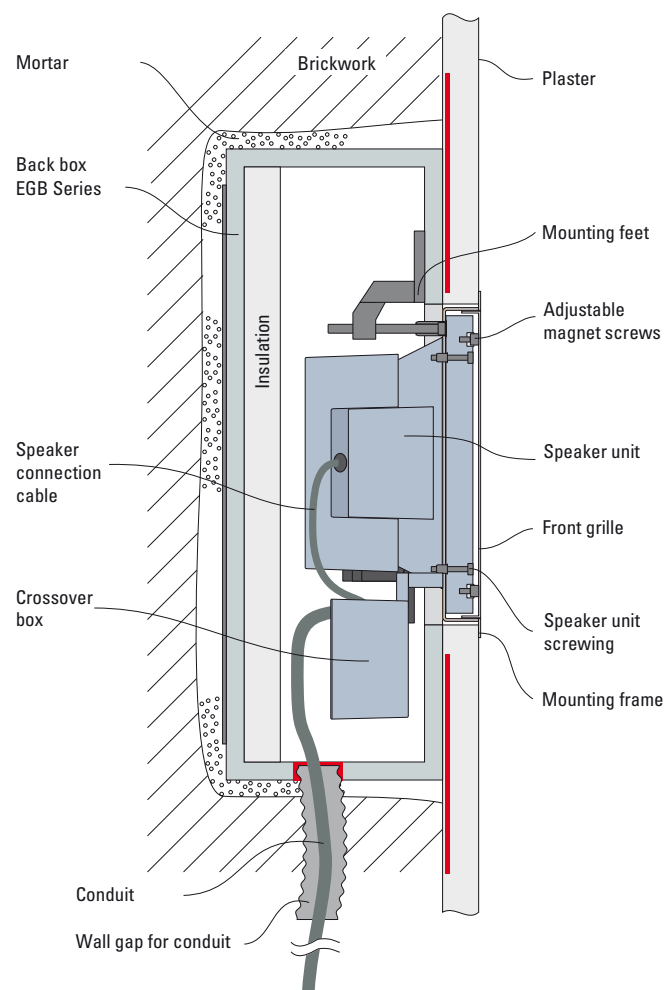

Back boxes (EGB Series)

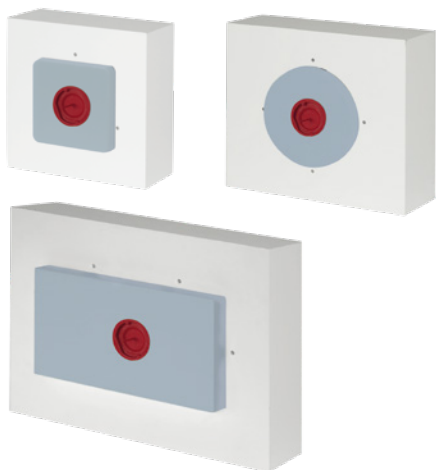

6. Installation in concrete ceilings using back boxes (EGB Series)

Fastening of the back box on the formwork

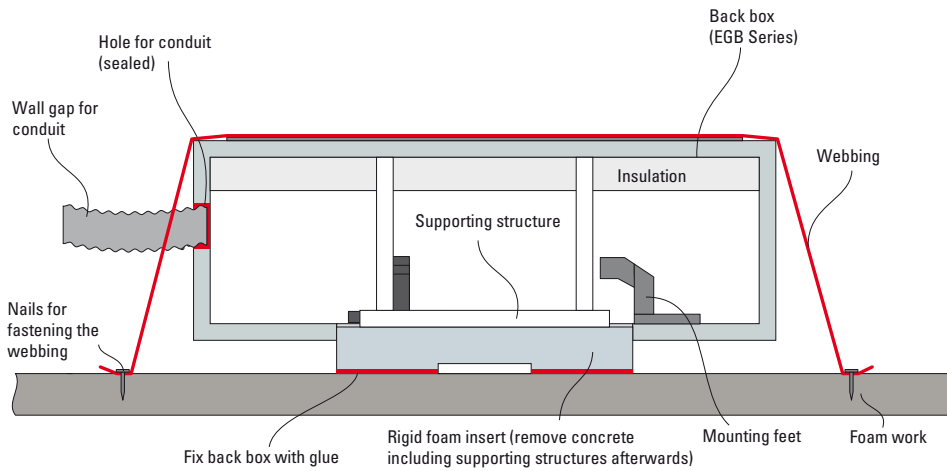

When installing speakers in concrete ceilings cast in place, please use our **EGB Series** plastic back boxes. The mounting feet for the speakers are already installed in these boxes. You will have to make the holes for cables in the back boxes.

Installation steps

- Use a conical drill bit to drill a hole for the cables or conduits in the side of the boxes and attach the cables.
- Place the boxes in the correct position on the formwork and attach the conduit.
- Use a laser level to adjust the position of the boxes.
- Fasten the back box to the formwork with webbing.

Secure the webbing tightly to the formwork board and cut to the correct length. The box can also be glued to the formwork to ensure it is precisely positioned.

When poured, the concrete flows under the box until it reaches the rigid foam insert. The layer under the box is 20 mm thick.

- After the formwork has been removed, insert the plaster guard provided into the rigid foam insert so you can see the position of the speakers after plastering. When plastering the ceiling, apply a layer of plaster to the rigid foam insert of the speaker back box. Use a hammer to knock off the plaster covering the rigid foam insert and uncover all of the opening.

- Use a sharp utility cutter to cut through the rigid foam along the edges of the installation opening. You can then remove the rigid foam insert and the support structure. Line the back box with the insulating wool provided.

Plastered concrete ceiling

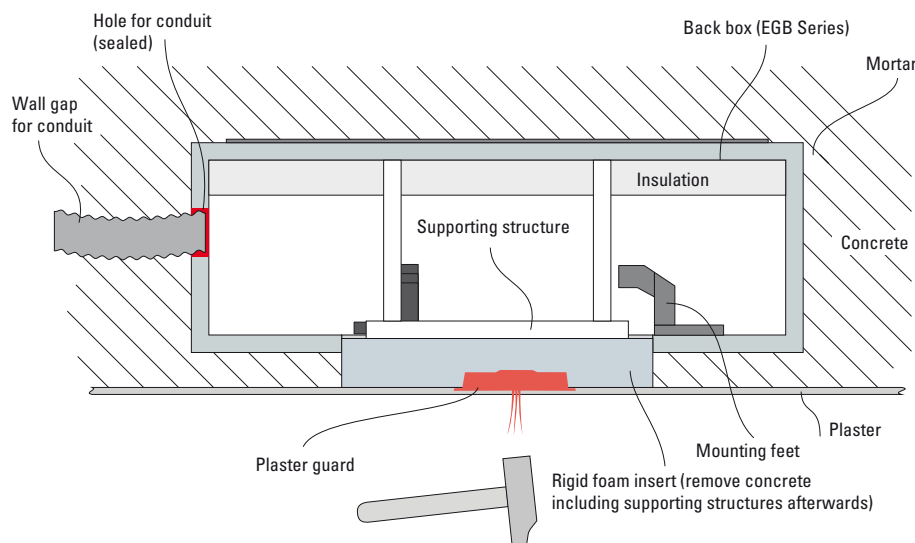

Back boxes (EGB Series)

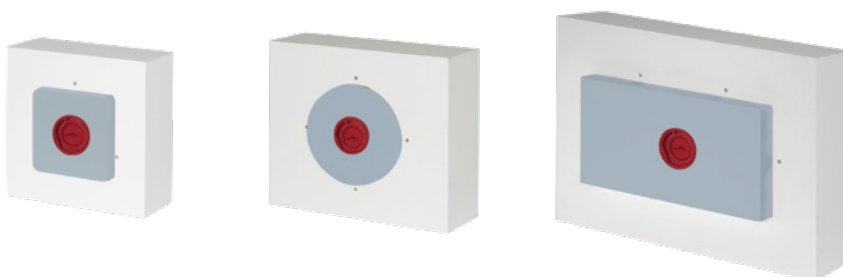

The speakers can then be installed in the same way as for drywall ceilings (see page 8).

Completely installed speaker in concrete ceiling

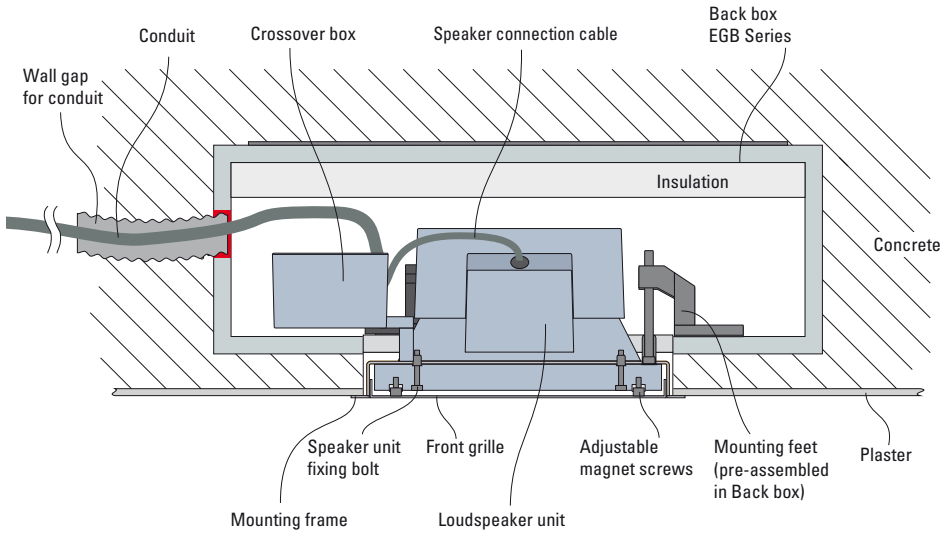







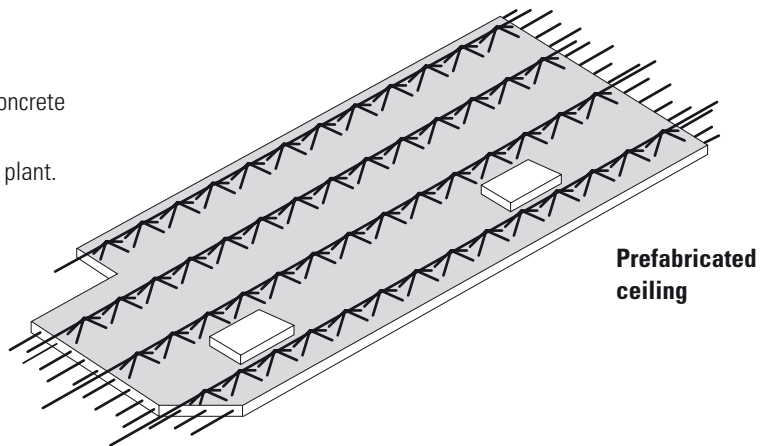

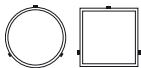

7. Installation in prefabricated concrete ceilings with the back boxes

If you are installing speakers in a prefabricated concrete ceiling, the EGB Series plastic back boxes must first be delivered to the concrete plant casting the ceiling. The boxes will be installed in the requisite ceiling modules at the plant.







The remaining installation steps are then carried out on the construction site.

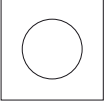
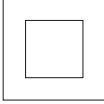

6. Technical data loudspeakers

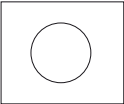
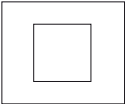
Models	Principle	Frequency range	Power capacity	Impedance	100 V Versions	Sensitivity	Dispersion	Dimensions	Cutout size	Installation depth	Weight
	DE 140 Polar DE 140 Q Polar	2-way hifi speaker with Polar technology	76 ... 21000 Hz RMS/Prog. 30/60 Watts	8 Ohms	7,5/15/30 Watts (100 V)	84 dB (1W/1m) max. 102 dB	180°	d=144 mm 144 x 144 mm (Q)	d=128 mm 128 x 128 mm (Q)	83 mm	1,2 kg
	DE 170 Polar DE 170 Q Polar	2-way hifi speaker with Polar technology	60 ... 21000 Hz RMS/Prog. 40/80 Watts	8 Ohms	7,5/15/30 Watts (100 V)	85 dB (1W/1m) max. 104 dB	180°	d=174 mm 174 x 174 mm (Q)	d=158 mm 158 x 158 mm (Q)	88 mm	1,3 kg
	DE 200 Polar DE 200 Q Polar	2-way hifi speaker with Polar technology	54 ... 21000 Hz RMS/Prog. 60/120 Watts	8 Ohms	7,5/15/30 Watts (100 V)	86 dB (1W/1m) max. 105 dB	180°	d=192 mm 192 x 192 mm (Q)	d=176 mm 176 x 176 mm (Q)	100 mm	2,1 kg
	DE 200 HSP DE 200 HSPQ Polar	2-way hifi speaker with Polar technology	96 ... 21000 Hz RMS/Prog. 60/120 Watts	8 Ohms	7,5/15/30 Watts (100 V)	93 dB (1W/1m) max. 115 dB	180°	d=192 mm bzw. 192 x 192 mm (Q)	d=176 mm 176 x 176 mm (Q)	102 mm	2,9 kg
	DE 300 R Polar	3-way hifi speaker with Polar technology	52 ... 21000 Hz RMS/Prog. 120/240 Watts	4 Ohms	on request	89 dB (1W/1m) max. 112 dB	180°	358 x 192 mm	342 x 176 mm	100 mm	3,8 kg
	DE 200 LP DE 200 LPQ	2-way hifi speaker with reduced mounting depth	75 ... 21000 Hz RMS/Prog. 40/80 Watts	8 Ohms	7,5/15/30 Watts (100 V)	85 dB (1W/1m) max. 106 dB	140°	d=192 mm 192 x 192 mm (Q)	d=176 mm 176 x 176 mm (Q)	50 mm	1,2 kg
	DE 200 CD DE 200 CDQ	2-way hifi in-wall speaker	54 ... 21000 Hz RMS/Prog. 60/120 Watts	8 Ohms	on request	88 dB (1W/1m) max. 109 dB	80°	d=192 mm 192 x 192 mm (Q)	d=176 mm 176 x 176 mm (Q)	100 mm	2,1 kg
	DE 300 CDR	3-way hifi in-wall speaker	52 ... 21000 Hz RMS/Prog. 120/240 Watts	4 Ohms	on request	89 dB (1W/1m) max. 112 dB	80°	358 x 192 mm	342 x 176 mm	100 mm	3,8 kg
	DE 300 FR	3-way in-ceiling speaker with Polar technology	57 ... 21000 Hz RMS/Prog. 80/160 Watts	4 Ohms	on request	87 dB (1W/1m) max. 109 dB	80° Beam direction -35° downwards	358 x 192 mm	342 x 176 mm	150 mm	4,2 kg
	DE 200 ST Polar DE 200 STQ Polar	Stereo 2-way in-ceiling speaker with Polar technology	54 ... 21000 Hz RMS/Prog. 2 x 40/80 Watts	2 x 8 Ohms	on request	86 dB (1W/1m) max. 108 dB	180°	d=192 mm 192 x 192 mm (Q)	d=176 mm 176 x 176 mm (Q)	100 mm	2,2 kg
	DE 300 SUB	Subwoofer	40 ... 250 Hz RMS/Prog. 120/240 Watts	4 Ohms	on request	83 dB (1W/1m) max. 107 dB	180°	358 x 192 mm	342 x 176 mm	100 mm	4,2 kg

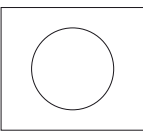
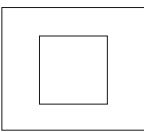
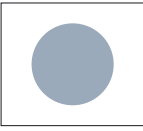
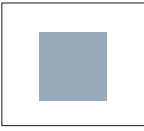
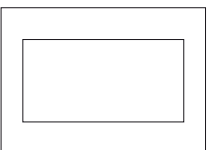
7. Technical data back boxes

Models		Application	Loudspeaker type	Dimensions W x H x D	Material	Weight	Accessories
		Drywall	DE 140 DE 140 Q	250 x 250 x 100 mm	Plastic foam	1,1 kg	Insulating wool
		Concrete walls Solid walls	DE 140 DE 140 Q	250 x 250 x 120 mm	Plastic foam and Form insert		Mounting material for formwork, Plaster guard, Insulating wool
		Drywall	DE 170 DE 170 Q	300 x 250 x 120 mm	Plastic foam	1,7 kg	Insulating wool
		Concrete walls Solid walls	DE 170 DE 170 Q	300 x 250 x 140 mm	Plastic foam and Form insert		Mounting material for formwork, Plaster guard, Insulating wool
		Drywall	DE 200 all models DE 200 Q all models	350 x 300 x 120 mm	Plastic foam	1,9 kg	Insulating wool
		Concrete walls Solid walls	DE 200 all models DE 200 Q all models	350 x 300 x 140 mm	Plastic foam and Form insert		Mounting material for formwork, Plaster guard, Insulating wool
		Drywall	DE 300 R DE 300 CDR DE 300 SUB	500 x 350 x 140 mm	Plastic foam	3,5 kg	Insulating wool
		Concrete walls Solid walls	DE 300 R DE 300 CDR DE 300 SUB	500 x 350 x 160 mm	Plastic foam and Form insert		Mounting material for formwork, Plaster guard, Insulating wool
		Drywall	DE 300 FR	500 x 350 x 180 mm	Plastic foam	3,9 kg	Insulating wool
		Concrete walls Solid walls	DE 300 FR	500 x 350 x 200 mm	Plastic foam and Form insert		Mounting material for formwork, Plaster guard, Insulating wool

DE installation videos
with or without back box
on Youtube

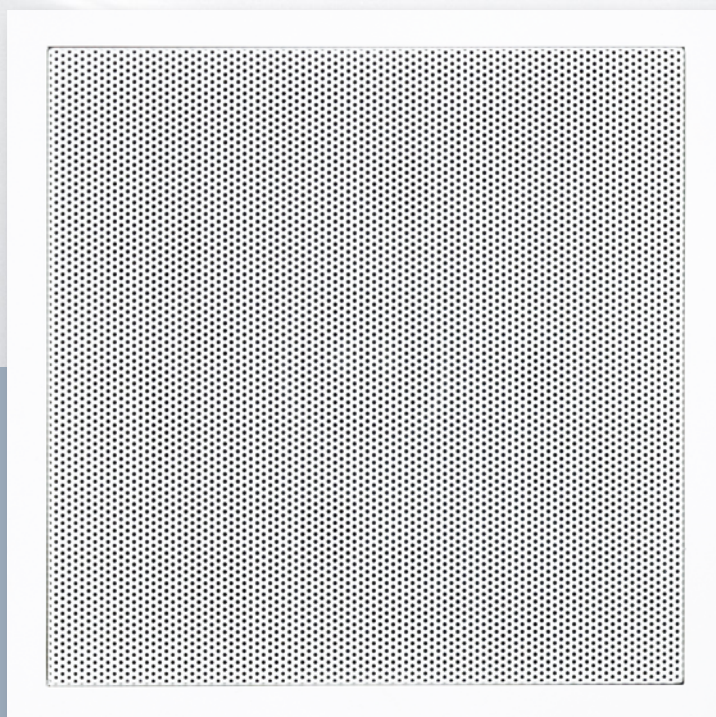

LB Lautsprecher
und Beschallungstechnik GmbH

info@lb-lautsprecher.de
www.lb-lautsprecher.de
www.feiner-hoeren.de
@LB_Audio_Components

Phone +49 89 1893109-0 · Fax -29

Kapellenstr. 10
85622 Feldkirchen by Munich

8/2023

Changes and errors excepted.

© LB Lautsprecher und Beschallungstechnik GmbH